

Data sheet | Item number: 769-101/022-000  
1-conductor female plug; angled; 4 mm<sup>2</sup>; 1-pole

769-101/022-000



RoHS  Compliant

[BOMcheck.net](https://www.bomcheck.net)

Color: ■

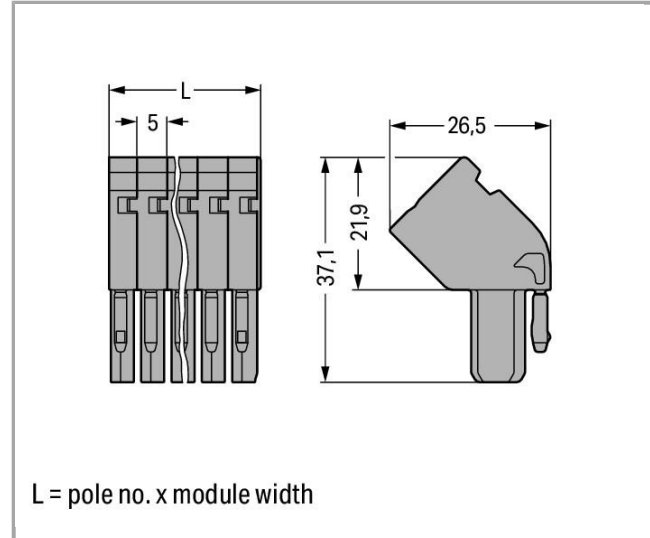

Item description

According to EN 61984, pluggable connectors without current interrupting capacity shall not be mated and unmated when live or under load.

## Data

### Electrical data

#### Ratings per IEC/EN 60664-1

Rated voltage (III / 3)	500 V
Rated impulse voltage (III / 3)	6 kV
Rated current	32 A

### Connection data

Connection technology	CAGE CLAMP®
Actuation type	Operating tool
Connectable conductor materials	Copper
Nominal cross section	4 mm <sup>2</sup>
Solid conductor	0.08 ... 4 mm <sup>2</sup> / 28 ... 12 AWG
Fine-stranded conductor	0.08 ... 4 mm <sup>2</sup> / 28 ... 12 AWG
Strip length	8 ... 9 mm / 0.31 ... 0.35 inch
No. of poles	1
Total number of connection points	1
Total number of potentials	1
Type of wiring	Front-entry wiring

### Geometrical Data

Width	5 mm / 0.197 inch
Height	37.1 mm / 1.461 inch
Depth	26.5 mm / 1.043 inch
Module width	5 mm / 0.197 inch

### Mechanical data

Marking level	Side marking
---------------	--------------

### Plug connection

Contact type (pluggable connector)	Female connector/socket
Connector connection type	for conductors

### Material Data

Color	gray
Insulating material	Polyamide 66 (PA 66)





Fire load	0.045 MJ
Weight	2.52 g

### Commercial data

Country of origin	DE
GTIN	4044918840088
Customs Tariff No.	85366990990

### Approvals / Certificates

#### Country specific Approvals

Logo	Approval	Additional Approval Text	Certificate name
	CCA DEKRA Certification B.V.	EN 60947	NTR NL-7626
	CCA DEKRA Certification B.V.	EN 61984	2190419.02
	CCA DEKRA Certification B.V.	IEC 61984	NL-47799
	CSA DEKRA Certification B.V.	C22.2 No. 158	1101144
	KEMA/KEUR DEKRA Certification B.V.	EN 60947	2190419.01

#### Ship Approvals

Logo	Approval	Additional Approval Text	Certificate name
	ABS American Bureau of Shipping	EN 60947	14-HG1293677-PDA

#### UL-Approvals

Logo	Approval	Additional Approval Text	Certificate name
	UR Underwriters Laboratories Inc.	UL 1977	E45171



UR  
Underwriters Laboratories Inc.

UL 1059

E45172

## Compatible products

### Coding



**Item no.: 769-435**  
Coding pin; for coding of female plugs; for carrier terminal blocks / male connectors

769-435

### Strain relief plate



**Item no.: 769-410**  
Strain relief plate

769-410

### Protective Warning Marker



**Item no.: 280-415**  
Protective warning marker; with high-voltage symbol, black; for 5 terminal blocks

280-415

### Insulation stop



**Item no.: 769-470**  
Insulation stop; 0.08 - 0.2 mm<sup>2</sup> "s" (0.14 mm<sup>2</sup> "f-st"); 5 pieces/strip

769-470



**Item no.: 769-471**  
Insulation stop; 0.25 - 0.5 mm<sup>2</sup>; 5 pieces/strip

769-471



**Item no.: 769-472**  
Insulation stop; 0.75 - 1 mm<sup>2</sup>; 5 pieces/strip

769-472

### check



**Item no.: 210-136**  
Test plug; 2 mm Ø; with 500 mm cable

210-136



**Item no.: 210-137**  
Test plug; 2.3 mm Ø; with 500 mm cable

210-137

### Marking accessories



**Item no.: 2009-115**  
WMB-Inline; for Smart Printer; on reel; stretchable 5 - 5.2 mm; plain; snap-on type

2009-115



**Item no.: 2009-115/000-002**  
WMB-Inline; for Smart Printer; on reel; stretchable 5 - 5.2 mm; plain; snap-on type

2009-115















/000-002

































**Item no.: 2009-115/000-006**  
WMB-Inline; for smartPRINTER; on reel; stretchable 5 - 5.2 mm; plain; snap-on type

2009-115





/000-006

	<b>Item no.: 2009-115/000-007</b> WMB-Inline; for Smart Printer; on reel; stretchable 5 - 5.2 mm; plain; snap-on type	/000-007	2009-115
	<b>Item no.: 2009-115/000-012</b> WMB-Inline; for smartPRINTER; on reel; stretchable 5 - 5.2 mm; plain; snap-on type	/000-012	2009-115
	<b>Item no.: 2009-115/000-017</b> WMB-Inline; for Smart Printer; on reel; stretchable 5 - 5.2 mm; plain; snap-on type	/000-017	2009-115
	<b>Item no.: 2009-115/000-023</b> WMB-Inline; for Smart Printer; on reel; stretchable 5 - 5.2 mm; plain; snap-on type	/000-023	2009-115
	<b>Item no.: 2009-115/000-024</b> WMB-Inline; for smartPRINTER; on reel; stretchable 5 - 5.2 mm; plain; snap-on type	/000-024	2009-115
	<b>Item no.: 2009-145</b> Mini-WSB Inline; for Smart Printer; on reel; stretchable 5 - 5.2 mm; plain; snap-on type		2009-145
	<b>Item no.: 2009-145/000-002</b> Mini-WSB Inline; for Smart Printer; on reel; stretchable 5 - 5.2 mm; plain; snap-on type	/000-002	2009-145
	<b>Item no.: 2009-145/000-005</b> Mini-WSB Inline; for Smart Printer; on reel; stretchable 5 - 5.2 mm; plain; snap-on type	/000-005	2009-145
	<b>Item no.: 2009-145/000-006</b> Mini-WSB Inline; for Smart Printer; on reel; stretchable 5 - 5.2 mm; plain; snap-on type	/000-006	2009-145
	<b>Item no.: 2009-145/000-007</b> Mini-WSB Inline; for Smart Printer; on reel; stretchable 5 - 5.2 mm; plain; snap-on type	/000-007	2009-145
	<b>Item no.: 2009-145/000-012</b> Mini-WSB Inline; for Smart Printer; on reel; stretchable 5 - 5.2 mm; plain; snap-on type	/000-012	2009-145
	<b>Item no.: 2009-145/000-023</b> Mini-WSB Inline; for smartPRINTER; on reel; stretchable 5 - 5.2 mm; plain; snap-on type	/000-023	2009-145
	<b>Item no.: 2009-145/000-024</b> Mini-WSB Inline; for Smart Printer; on reel; stretchable 5 - 5.2 mm; plain; snap-on type	/000-024	2009-145
	<b>Item no.: 248-501</b> Miniature WSB Quick marking system; plain; Marker width 5 mm; 10 strips with 10 markers per card		248-501
	<b>Item no.: 248-501/000-002</b> Mini-WSB marking card; as card; not stretchable; plain; snap-on type	/000-002	248-501

	<b>Item no.: 248-501/000-005</b> Mini-WSB marking card; as card; not stretchable; plain; snap-on type	/000-005	248-501
	<b>Item no.: 248-501/000-006</b> Mini-WSB marking card; as card; not stretchable; plain; snap-on type	/000-006	248-501
	<b>Item no.: 248-501/000-007</b> Mini-WSB marking card; as card; not stretchable; plain; snap-on type	/000-007	248-501
	<b>Item no.: 248-501/000-012</b> Mini-WSB marking card; as card; not stretchable; plain; snap-on type	/000-012	248-501
	<b>Item no.: 248-501/000-017</b> Mini-WSB marking card; as card; not stretchable; plain; snap-on type	/000-017	248-501
	<b>Item no.: 248-501/000-023</b> Mini-WSB marking card; as card; not stretchable; plain; snap-on type	/000-023	248-501
	<b>Item no.: 248-501/000-024</b> Mini-WSB marking card; as card; not stretchable; plain; snap-on type	/000-024	248-501
	<b>Item no.: 793-501</b> WMB marking card; as card; not stretchable; plain; snap-on type		793-501
	<b>Item no.: 793-501/000-002</b> WMB marking card; as card; not stretchable; plain; snap-on type	/000-002	793-501
	<b>Item no.: 793-501/000-005</b> WMB marking card; as card; not stretchable; plain; snap-on type	/000-005	793-501
	<b>Item no.: 793-501/000-006</b> WMB marking card; as card; not stretchable; plain; snap-on type	/000-006	793-501
	<b>Item no.: 793-501/000-007</b> WMB marking card; as card; not stretchable; plain; snap-on type	/000-007	793-501
	<b>Item no.: 793-501/000-012</b> WMB marking card; as card; not stretchable; plain; snap-on type	/000-012	793-501
	<b>Item no.: 793-501/000-017</b> WMB marking card; as card; not stretchable; plain; snap-on type	/000-017	793-501
	<b>Item no.: 793-501/000-023</b> WMB marking card; as card; not stretchable; plain; snap-on type	/000-023	793-501

	<b>Item no.: 793-501/000-024</b> WMB marking card; as card; not stretchable; plain; snap-on type	793-501 /000-024
	<b>Item no.: 793-5501</b> WMB marking card; as card; for terminal block width 5 - 17.5 mm; stretchable 5 - 5.2 mm; plain; snap-on type	793-5501
	<b>Item no.: 793-5501/000-002</b> WMB marking card; as card; for terminal block width 5 - 17.5 mm; stretchable 5 - 5.2 mm; plain; snap-on type	793-5501 /000-002
	<b>Item no.: 793-5501/000-005</b> WMB marking card; as card; stretchable 5 - 5.2 mm; plain; snap-on type	793-5501 /000-005
	<b>Item no.: 793-5501/000-006</b> WMB marking card; as card; stretchable 5 - 5.2 mm; plain; snap-on type	793-5501 /000-006
	<b>Item no.: 793-5501/000-007</b> WMB marking card; as card; stretchable 5 - 5.2 mm; plain; snap-on type	793-5501 /000-007
	<b>Item no.: 793-5501/000-012</b> WMB marking card; as card; stretchable 5 - 5.2 mm; plain; snap-on type	793-5501 /000-012
	<b>Item no.: 793-5501/000-017</b> WMB marking card; as card; stretchable 5 - 5.2 mm; plain; snap-on type	793-5501 /000-017
	<b>Item no.: 793-5501/000-023</b> WMB marking card; as card; stretchable 5 - 5.2 mm; plain; snap-on type	793-5501 /000-023
	<b>Item no.: 793-5501/000-024</b> WMB marking card; as card; stretchable 5 - 5.2 mm; plain; snap-on type	793-5501 /000-024
<b>ferrule</b>		
	<b>Item no.: 216-101</b> Ferrule; Sleeve for 0.5 mm <sup>2</sup> / AWG 22; uninsulated; electro-tin plated	216-101
	<b>Item no.: 216-102</b> Ferrule; Sleeve for 0.75 mm <sup>2</sup> / AWG 20; uninsulated; electro-tin plated	216-102
	<b>Item no.: 216-103</b> Ferrule; Sleeve for 1 mm <sup>2</sup> / AWG 18; uninsulated; electro-tin plated	216-103
	<b>Item no.: 216-104</b> Ferrule; Sleeve for 1.5 mm <sup>2</sup> / AWG 16; uninsulated; electro-tin plated	216-104
	<b>Item no.: 216-201</b> Ferrule; Sleeve for 0.5 mm <sup>2</sup> / 20 AWG; insulated; electro-tin plated	216-201
	<b>Item no.: 216-202</b> Ferrule; Sleeve for 0.75 mm <sup>2</sup> / 18 AWG; insulated; electro-tin plated	216-202



	<b>Item no.: 216-203</b> Ferrule; Sleeve for 1 mm <sup>2</sup> / AWG 18; insulated; electro-tin plated	216-203
	<b>Item no.: 216-204</b> Ferrule; Sleeve for 1.5 mm <sup>2</sup> / AWG 16; insulated; electro-tin plated	216-204
	<b>Item no.: 216-206</b> Ferrule; Sleeve for 2.5 mm <sup>2</sup> / AWG 14; insulated; electro-tin plated	216-206
	<b>Item no.: 216-301</b> Ferrule; Sleeve for 0.25 mm <sup>2</sup> / AWG 24; insulated; electro-tin plated	216-301
	<b>Item no.: 216-302</b> Ferrule; Sleeve for 0.34 mm <sup>2</sup> / 22 AWG; insulated; electro-tin plated	216-302

Downloads

Documentation

Bid Text

769-101/022-000	doc 23.0 kB	Download
-----------------	----------------	----------

CAD/CAE - Smart Data

CAD data

3D Download 769-101/022-000	URL	Download
-----------------------------	-----	----------

Product family

**X-COM**

[Learn more about the product family.](#)

[Show all products from the family](#)

Subject to changes.